



## How to use the BTRM in Remote Enclosures

Part Number: BTRM-200

Product Release Date: April 01, 2013

Software version: BTRM2\_2013-05-06\_2316\_DNPV2V130D

The Ventev® Battery Test Remote Monitor (BTRM) has two independent, isolated relay contacts for alarm indications. The contacts are normally open when power is off. The user can select normally open or normally closed under an alarm condition. The maximum relay ratings for the contact are 60 Volts, 80 milliamps. It is not recommended that it be used to operate AC line connected equipment. The two dry contacts are available for basic RTU functionality. Example configurations include:

- Door Alarm
- AC Power Off
- DC Power On

### Door Alarm

The most common application for the relay contacts is a door alarm. The door alarm consists of an adjustable, polycarbonate pin switch and a door bracket for the pin switch. A DC voltage is applied to the pin switch as shown in Figure 1. The negative contact of the alarm does not have to be connected in order to complete the circuit, since the negative contacts of the BTRM are tied together internally.

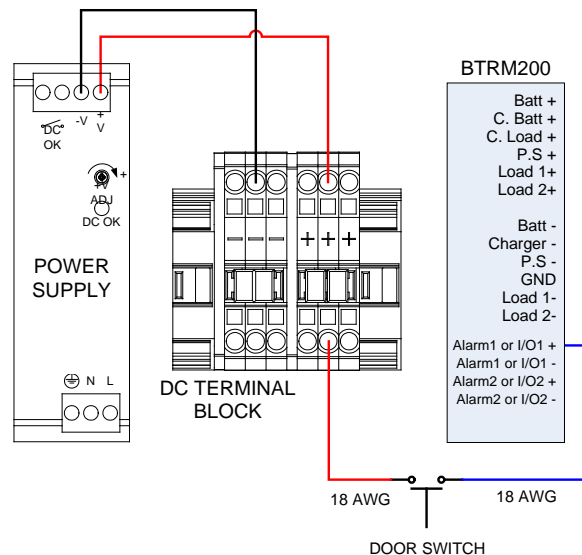

Figure 1: Door Alarm Wiring Configuration

Once the alarm electrical connections have been made, the BTRM I/O needs to be configured. Go to [www.ventev.com/BTRM](http://www.ventev.com/BTRM), and click on the "Port Options" tab on the left. Then go to the BTRM I/O options page (configure arrow in Figure 2). Under the I/O channel being used for the alarm, set the "Digital Input Alarm if > 2V" (setting arrow in Figure 2).

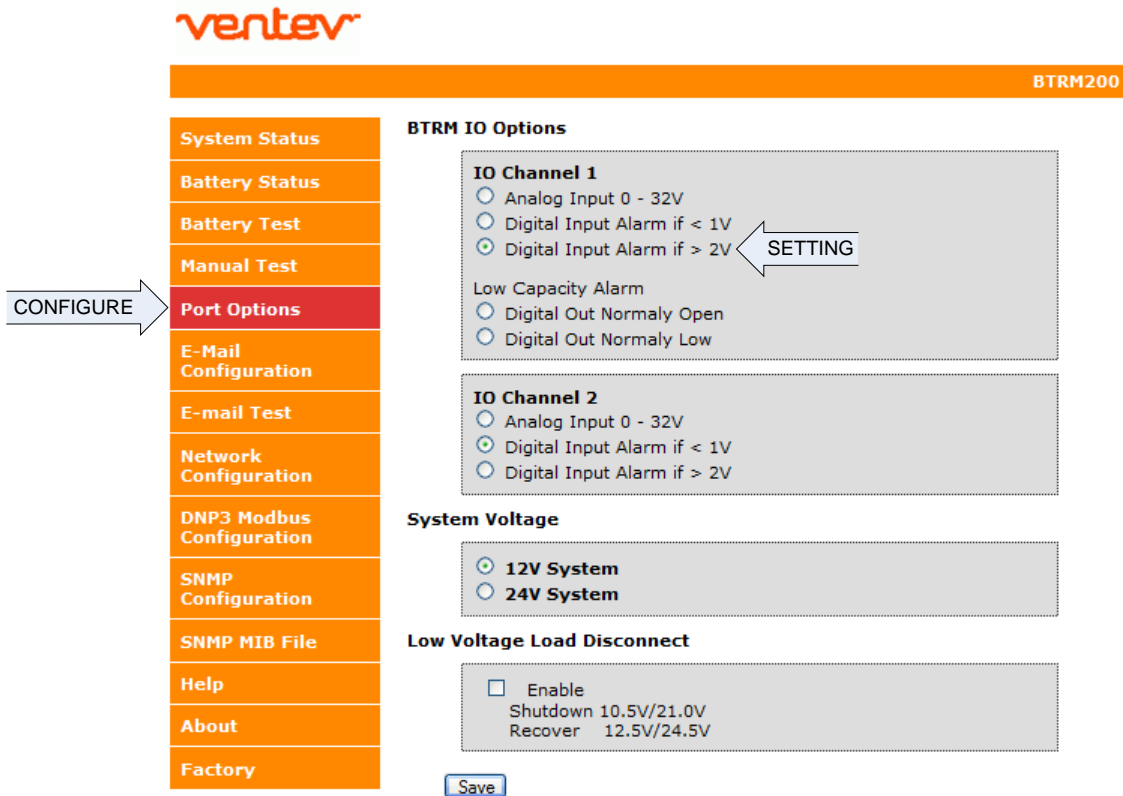

Figure 2: BTRM I/O Options for Door Alarm

The door alarm status is shown on the BTRM status home page (Figure 3). When the door on the enclosure is closed, the polycarbonate pin switch will be open-circuited. There is no voltage going to the contact on the BTRM. The alarm indication will show "0V" for "Analog V" and "False" for "Digital In." When the door on the enclosure is opened, the polycarbonate pin switch will close the circuit. There will be a voltage going to the contact on the BTRM. The alarm indication will show the voltage from the DC terminal block for "Analog V" and "True" for "Digital In." "True" indicates that an alarm message has been sent from the BTRM to the IT network.

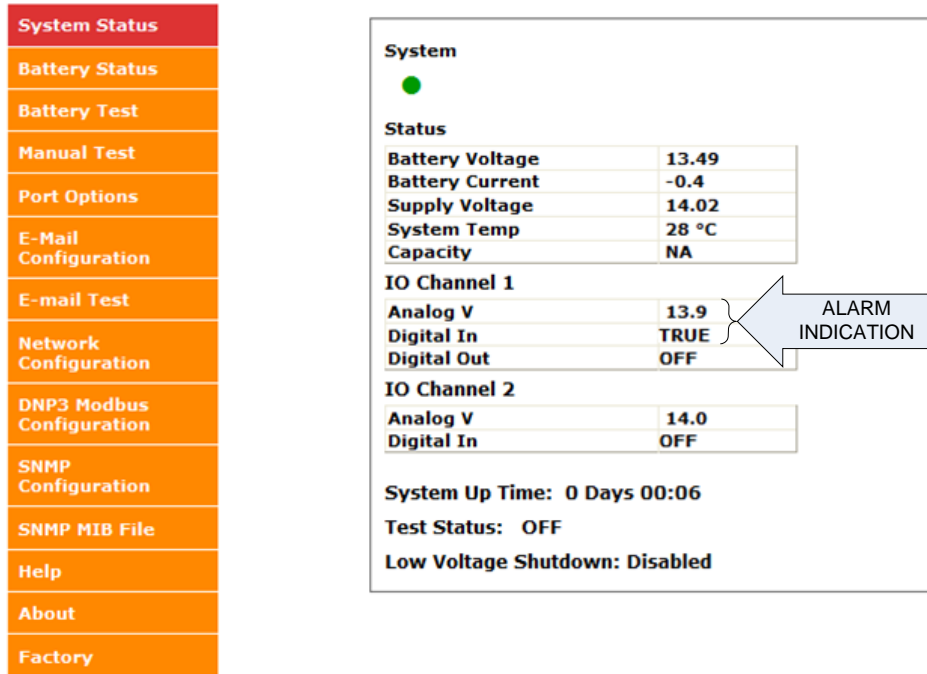

Figure 3: BTRM Status Home Page Showing Door Alarm Indication

### AC Power Off

Another application for the relay contacts is an AC Power Off alarm. The AC Power Off alarm works in conjunction with DC OK dry contacts of a power supply. A positive DC voltage is applied to the BTRM relay via the DC OK contacts as shown in Figure 4. The negative contact of the BTRM I/O connects to the negative DC voltage.

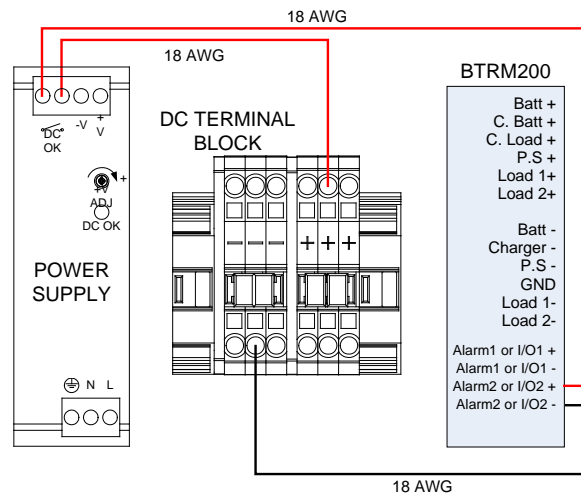

Figure 4: AC Alarm Wiring Configuration

Once the alarm electrical connections have been made, configure the BTRM I/O by going to [www.ventev.com/BTRM](http://www.ventev.com/BTRM). Click on the “Port Options” tab on the left, then go to the BTRM I/O options page (configure arrow in Figure 5). Under the I/O channel being used for the alarm, set the “Digital Input Alarm if < 1V” (setting arrow in Figure 5).

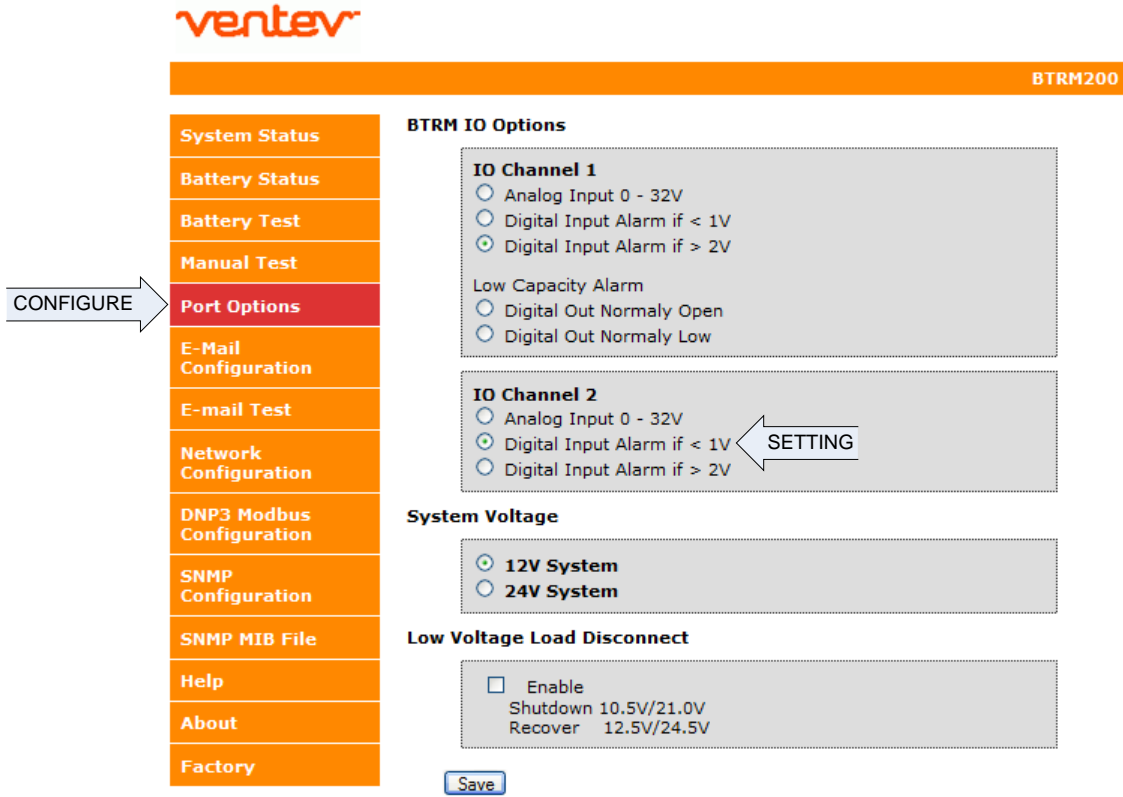

Figure 5: BTRM I/O Options for AC Alarm

The AC alarm status is shown on the BTRM status home page (Figure 6). When the AC power to the enclosure is present, the DC OK relay in the power supply is closed. A closed-loop circuit is made between the power supply and the BTRM. The alarm indication will show the voltage from the DC terminal block for “Analog V” and “False” for “Digital In.” When the AC power to the enclosure is disconnected, the DC OK relay in the power supply is open. The circuit between the power supply and the BTRM is now open. The alarm indication will show “0V” for “Analog V” and “True” for “Digital In.” “True” indicates that an alarm message has been sent from the BTRM to the IT network.

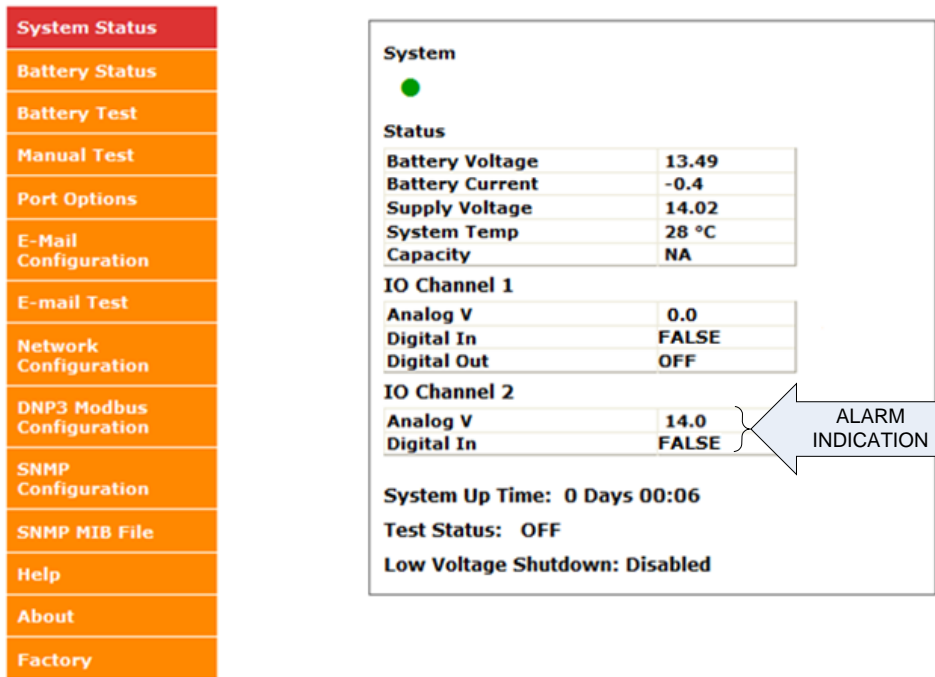

Figure 6: BTRM Status Home Page Showing AC Power Indication

DC Power On

An application similar to the AC Power Off alarm is the DC Power Alarm. This alarm works in conjunction with a DC power distribution panel. The positive and negative contacts of the DC distribution connect to the respective BTRM relay contacts as shown in Figure 7.

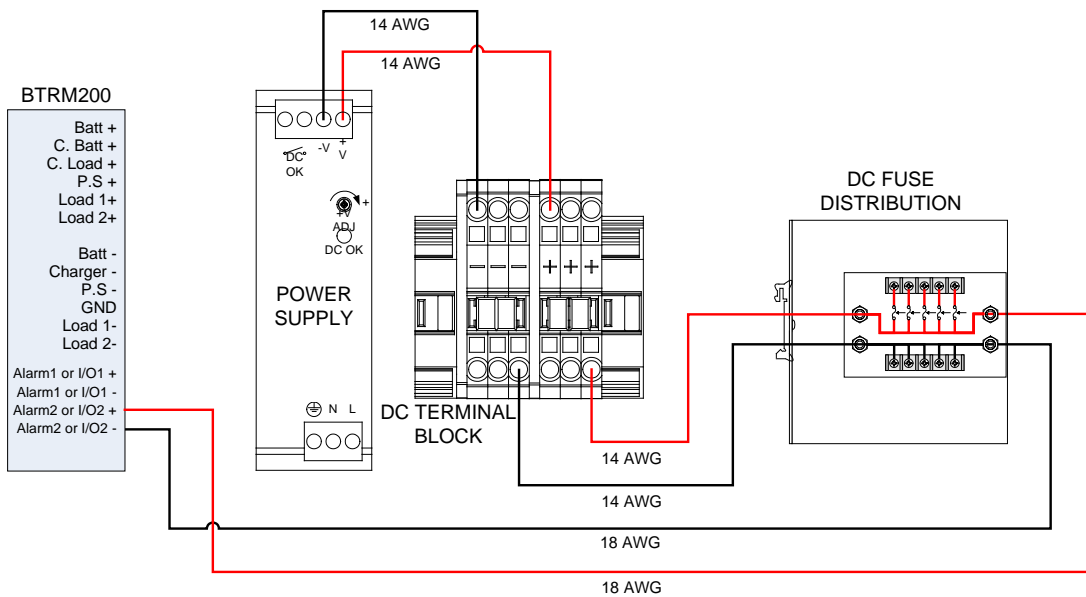

Figure 7: DC Alarm Wiring Configuration

Once the alarm electrical connections have been made, configure the BTRM I/O by going to [www.ventev.com/BTRM](http://www.ventev.com/BTRM). Click on the “Port Options” tab on the left and go to the BTRM I/O options page (configure arrow in Figure 8). Under the I/O channel being used for the alarm, set the “Digital Input Alarm if < 1V” (setting arrow in Figure 8).

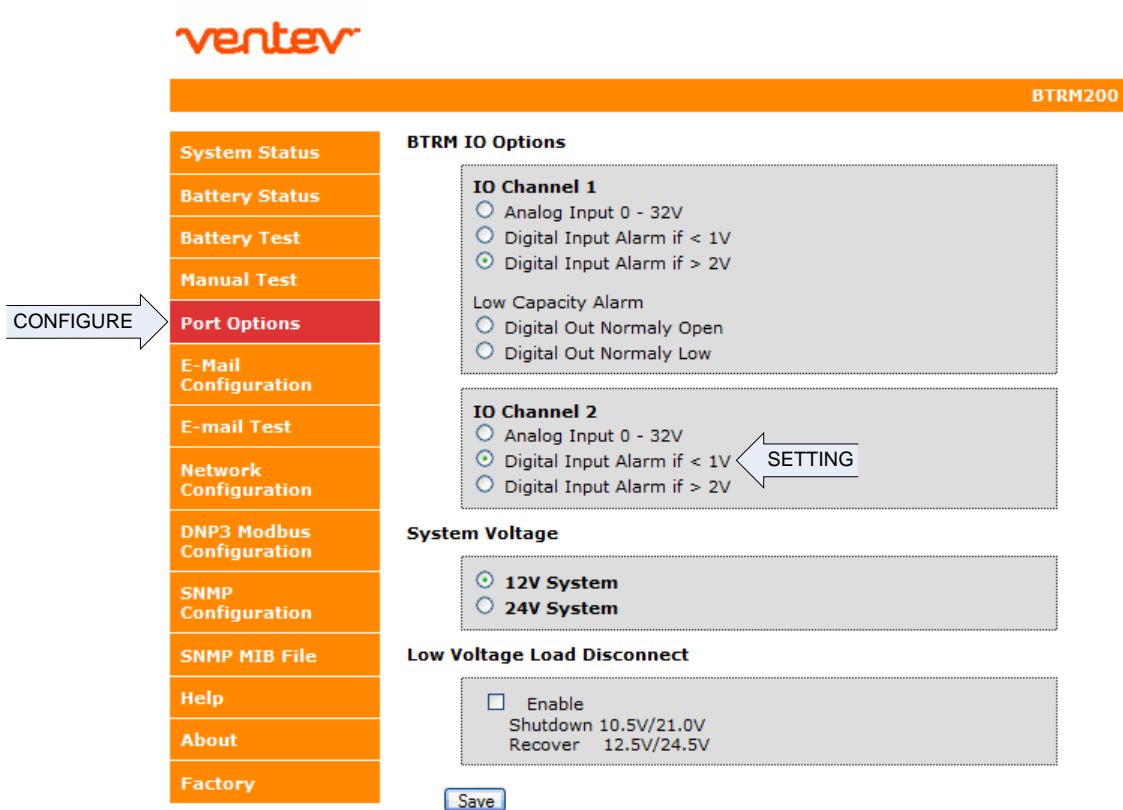

Figure 8: BTRM I/O Options for DC Alarm

The DC alarm status is shown on the BTRM status home page (Figure 6). When power is applied to the DC distribution, there is a voltage going to the contact on the BTRM. The alarm indication will show the voltage from the DC terminal block for “Analog V” and “False” for “Digital In”. When the DC power is removed from the DC distribution, there is no voltage going to the contact on the BTRM. The alarm indication will show “0V” for “Analog V” and “True” for “Digital In.” “True” indicates that an alarm message has been sent from the BTRM to the IT network.

The screenshot displays the BTRM Status Home Page. On the left is a navigation menu with the following items: System Status, Battery Status, Battery Test, Manual Test, Port Options, E-Mail Configuration, E-mail Test, Network Configuration, DNP3 Modbus Configuration, SNMP Configuration, SNMP MIB File, Help, About, and Factory. The main content area shows the following data:

**System**  
●

**Status**

Battery Voltage	13.49
Battery Current	-0.4
Supply Voltage	14.02
System Temp	28 °C
Capacity	NA

**IO Channel 1**

Analog V	0.0
Digital In	FALSE
Digital Out	OFF

**IO Channel 2**

Analog V	14.0
Digital In	FALSE

**System Up Time: 0 Days 00:06**  
**Test Status: OFF**  
**Low Voltage Shutdown: Disabled**

A callout box with the text "ALARM INDICATION" points to the "Analog V" value of 14.0 in the IO Channel 2 table.

Figure 6: BTRM Status Home Page Showing AC Power Indication

### Additional Applications

The two independent, isolated relay contacts in the BTRM can also be used for:

- Checking component voltages
- Activating a camera when an alarm indication occurs
- Monitoring thermal conditions via thermal couple
- Relaying low battery capacity alarm to SCADA radio.
- Operating external DC relays to control audible alerts or alarm lights